

Accelerators for America's Future

ACCELERATORS

-

MODERN SHIPS OF DISCOVERY



October 26, 2009

MODERN SHIPS OF DISCOVERY

- **THEY** (*accelerators and the detectors that go with them*) **TAKE US WHERE WE CANNOT GO UNAIDED**
- **ENABLE US TO SEE WHAT WE CANNOT SEE UNAIDED**
- **OUR STORY WILL**
 - tell of ships and adventures we've had (*tiny fraction*)
 - ships and adventures that are soon to be launched
 - ideas about possible ships for the future and **what it takes to make them happen**

MODERN SHIPS OF DISCOVERY

We'll be seeing about frontiers in

- Nuclear science
- Elementary particle science
- X-ray science
- Neutron science
- Science of Accelerators themselves

MODERN SHIPS OF DISCOVERY

- The Age of Accelerators began in the 1930's - well within living memory today - i.e. *modern*
- The very first startling result was realization of the Alchemists dream - changing one element into another (not lead into gold, however)
- in this case



{ 300 keV ~ "3 billion °C" }

MODERN SHIPS OF DISCOVERY

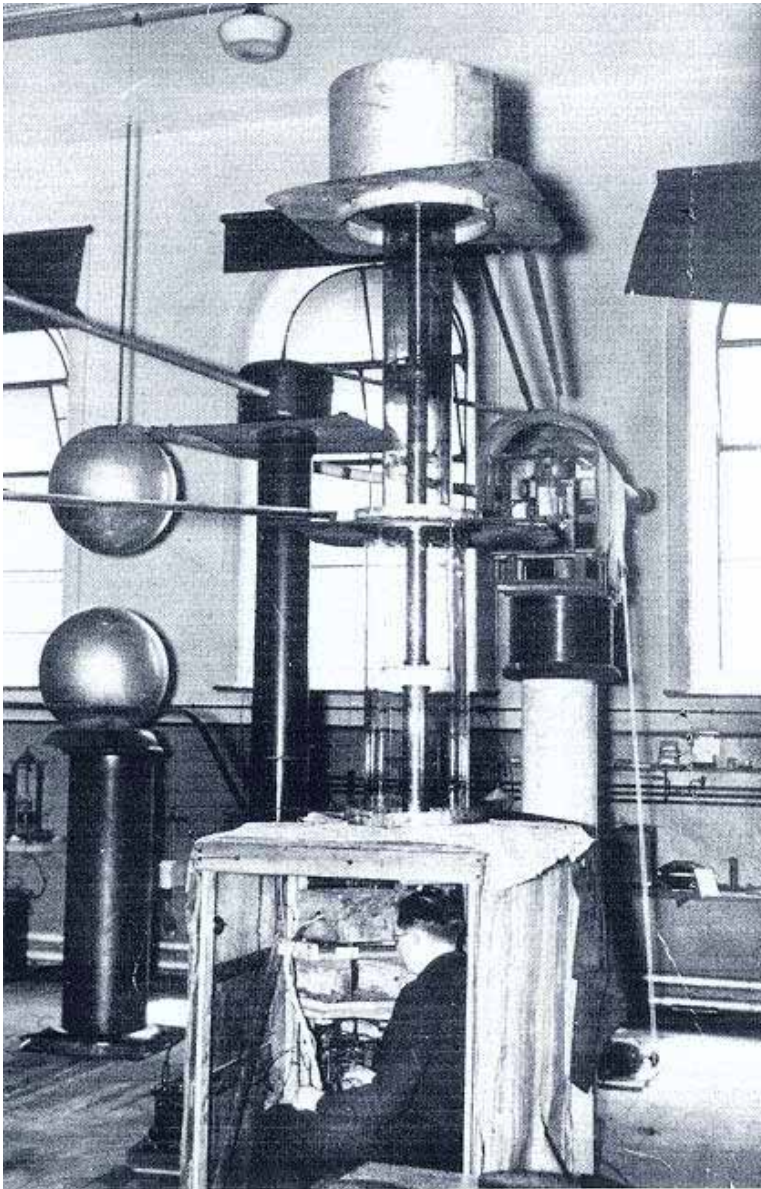

“Cockcroft-Walton Machine”
(Rutherford's lab in
Cambridge)

(300 keV) $p + Li \rightarrow Be^*$

Intensive and Extensive
accelerator R&D between
then and now has made
spectacular strides

MODERN SHIPS OF DISCOVERY

Other amazing accelerator enabled results in
Nuclear Science

- Creation of more than 25 new chemical elements beginning with element 93, Np
- Measurements leading to understanding of power source of the sun and other stars
- Discovery that neutrons and protons change their character when inside nuclei
- Discovery of the "strong quark gluon plasma" - a state that may have existed early in the universe

MODERN SHIPS OF DISCOVERY

A very small sample of the machines that took us there

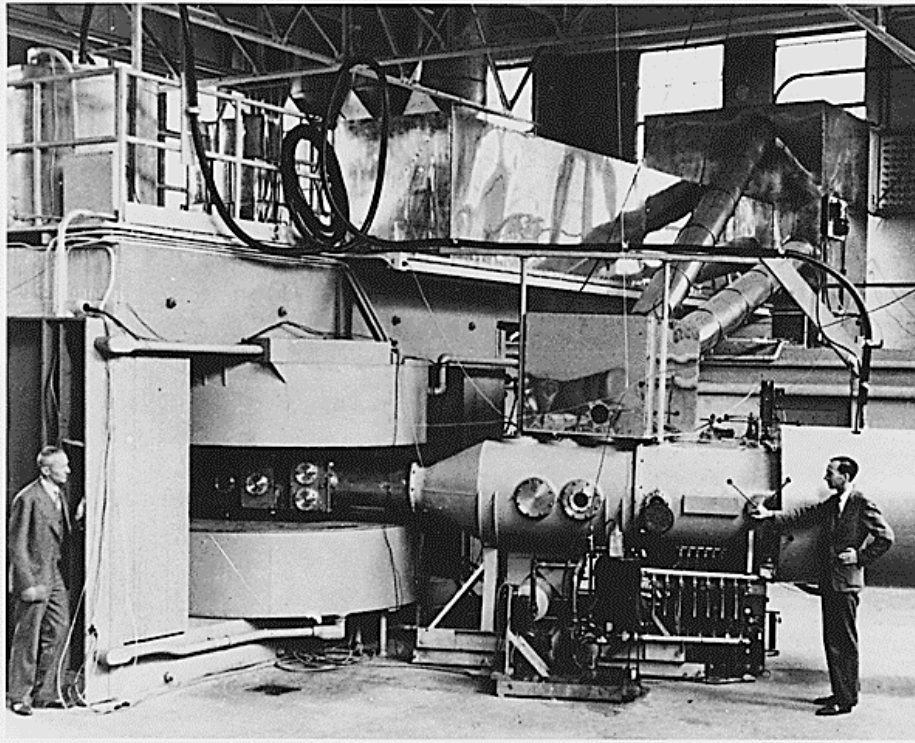

60 inch cyclotron

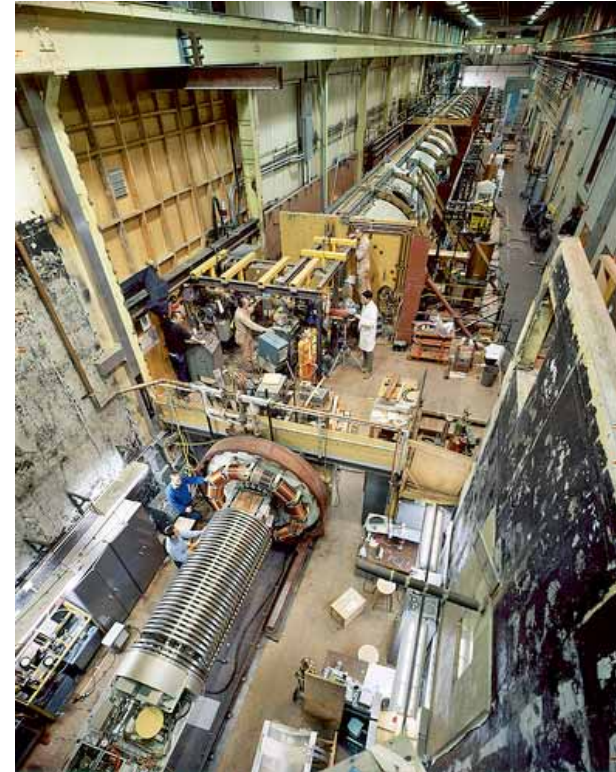

Super Hilac

MODERN SHIPS OF DISCOVERY

Collides heavy nuclei e.g. Au



3.8 km circumference
0.1 TeV/nucleon
~20 TeV on 20 TeV (10^{12})
for Gold

RHIC

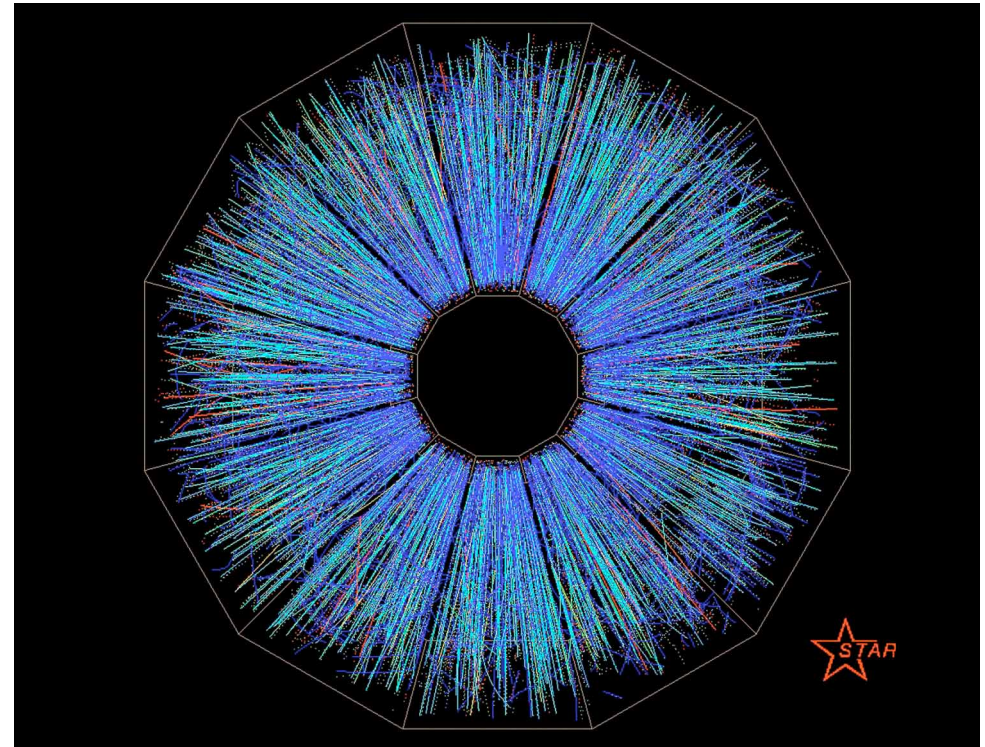

Picture of Gold nuclei colliding
showing "strong quark-gluon
plasma" *a state that may have
existed shortly after the
"big bang"*

MODERN SHIPS OF DISCOVERY

To

a very few of the amazing discoveries

in

Elementary Particle Science

MODERN SHIPS OF DISCOVERY

Discovery of:

- anti-proton showing matter-antimatter symmetry
- partons in protons by electron scattering
- J/psi meson
- two different neutrinos
- top quark

MODERN SHIPS OF DISCOVERY

These and many other measurements and discoveries established the "Standard Model" of the visible world

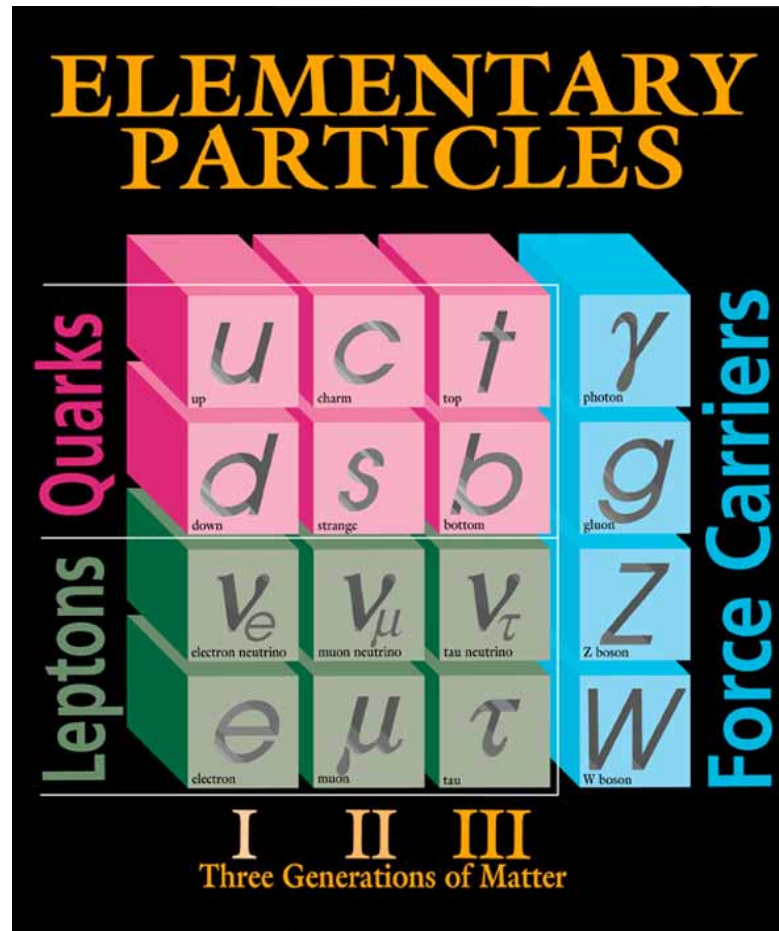

MODERN SHIPS OF DISCOVERY

A very small sample of the machines that took us there

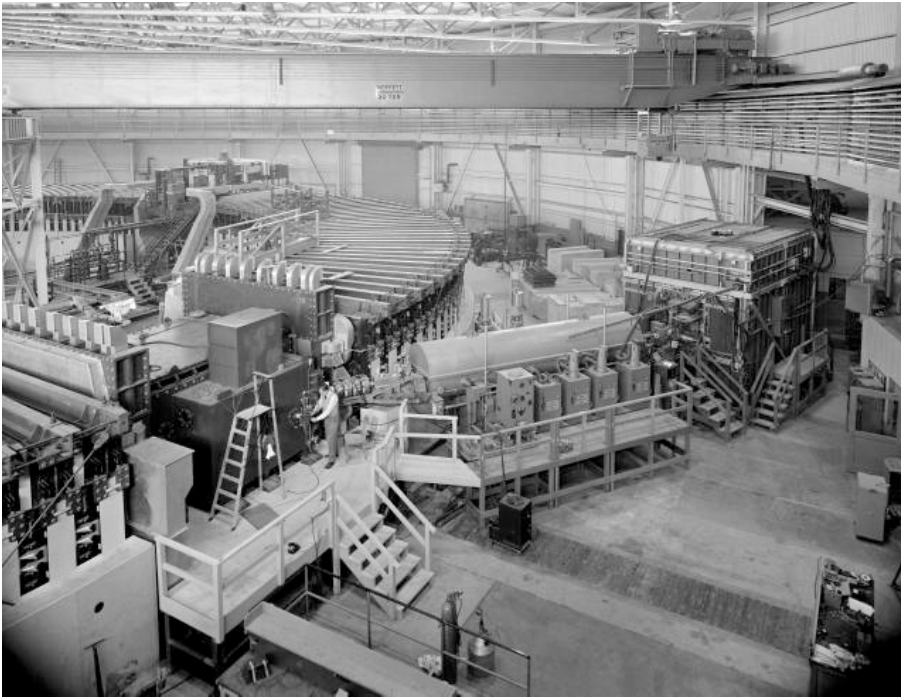

Bevatron 6.2 GeV (10^9 eV)



SLAC linac 3 km 50 GeV

MODERN SHIPS OF DISCOVERY



**Tevatron 6 km circumference
1 TeV on 1 TeV collider
(10^{12} eV)**



AGS 30 GeV 1km around

MODERN SHIPS OF DISCOVERY

To

some outstanding results in

X-ray based Science

using synchrotron radiation from accelerators

MODERN SHIPS OF DISCOVERY

- Structure of rhinovirus -lead way to 3D of others
- Potassium channel in cell wall for nerve transmission
- Diamond anvil cell high pressure mineral phases
- Real time imaging of, e.g. insect breathing
- Magnetic scattering
- Structure of the ribosome

MODERN SHIPS OF DISCOVERY

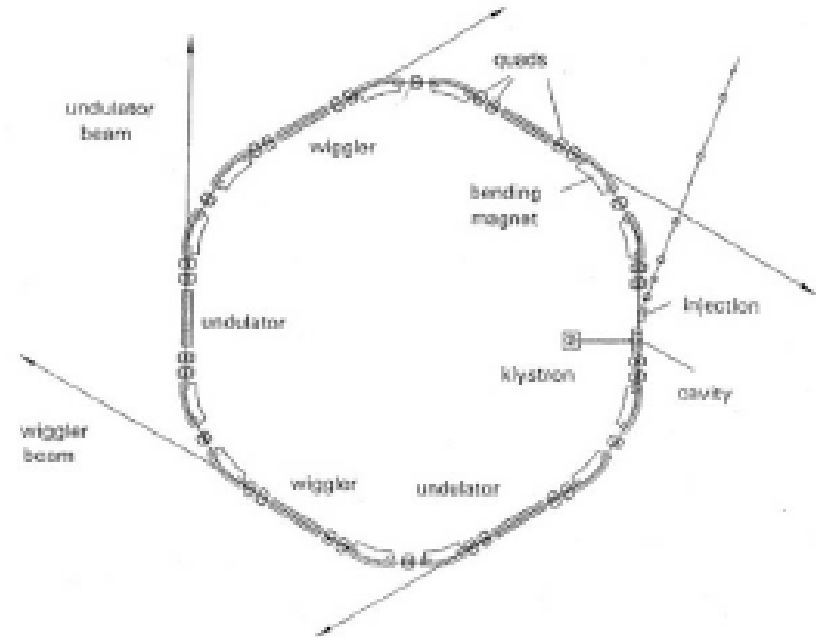
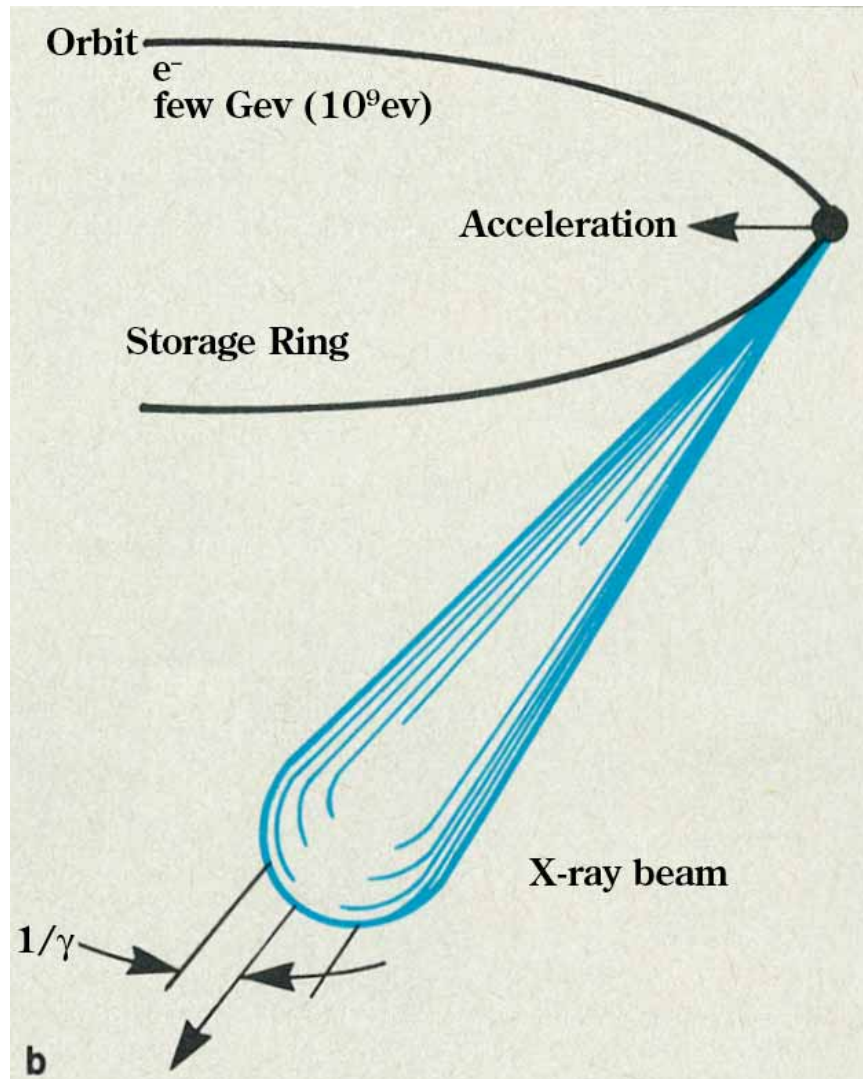

Storage Ring

10's of users of the SR can work simultaneously

MODERN SHIPS OF DISCOVERY

Facilities that house storage rings for hard X-rays



7 GeV, 1.1 km circumference

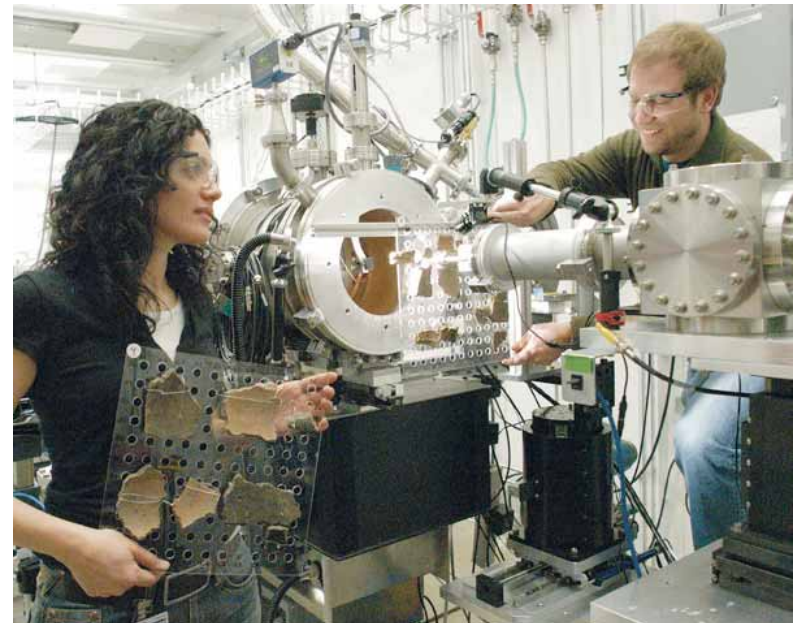

at a beamline

The Advanced Photon Source, one of six "hard" X-ray sources in the US

MODERN SHIPS OF DISCOVERY

to some outstanding results in

Neutron Assisted Science

based on accelerator produced neutrons

(several results reported from work abroad)

MODERN SHIPS OF DISCOVERY

- magnetic resonance in iron pnictide associated with Hi Tc superconductivity
- structure details of “colossal magneto resistance” materials
- change in structure of water with pressure near freezing
- structure of important ionic liquids
- 2 phases of C60 (*BES logo*)

MODERN SHIPS OF DISCOVERY

US Accelerator based **neutrons**

inside S N S

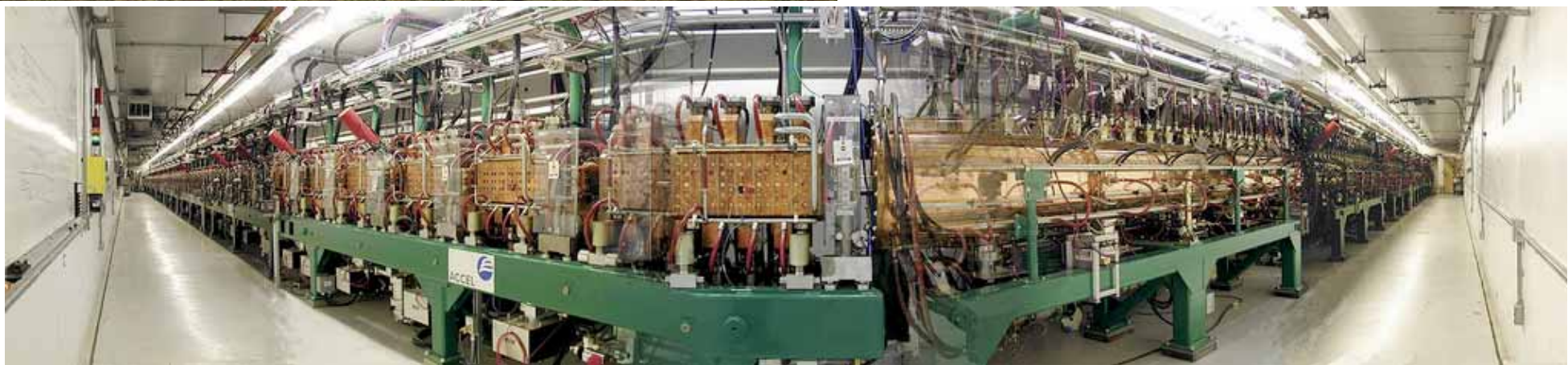

MODERN SHIPS OF DISCOVERY

to

THE SCIENCE OF ACCELERATORS THEMSELVES

MODERN SHIPS OF DISCOVERY

- in addition to the many accomplishments exemplified by the accelerators we've just seen examples of
- in addition to the many developments of the underlying science and technology on which those accelerators are founded
- there are recent advances of special note which exploit the plasma medium in which separation of charges can support enormous electromagnetic fields
- two approaches are being developed: producing the separation with **particle beams** or with **lasers**

MODERN SHIPS OF DISCOVERY

Beam driven plasma acceleration

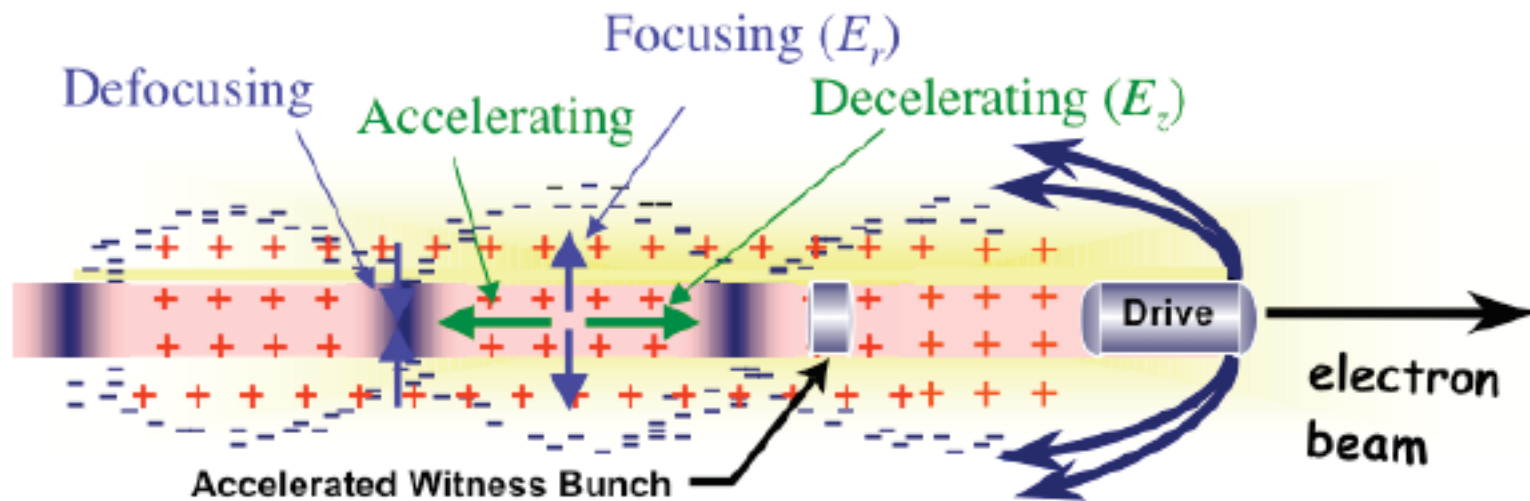

the "drive" electron beam deposits energy in the plasma in the form of a charge separation which accelerates the "witness" beam of electrons to a high energy

MODERN SHIPS OF DISCOVERY

Beam driven plasma acceleration results

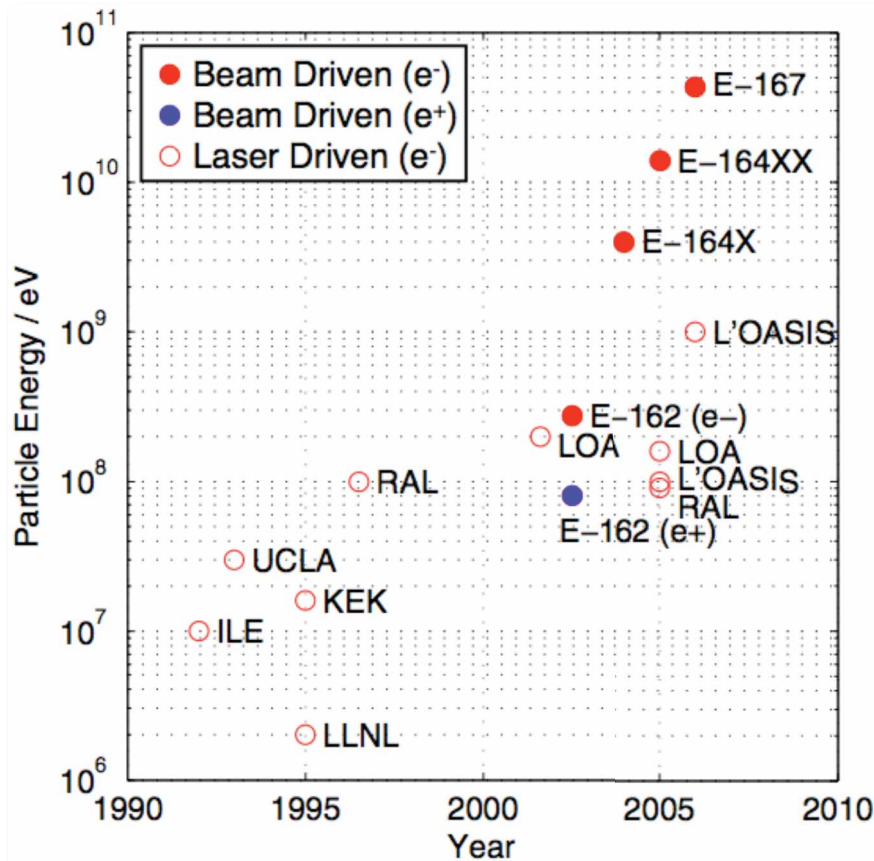

- Measured Accelerating Gradients of ~ 50 GeV/m (3,000 x SLAC)
- Many aspects of beam-plasma interaction have been studied:
- Focusing & transport
- Radiation production
- Refraction/Boundary effects
- Acceleration of e^- and e^+

MODERN SHIPS OF DISCOVERY

Laser driven plasma acceleration

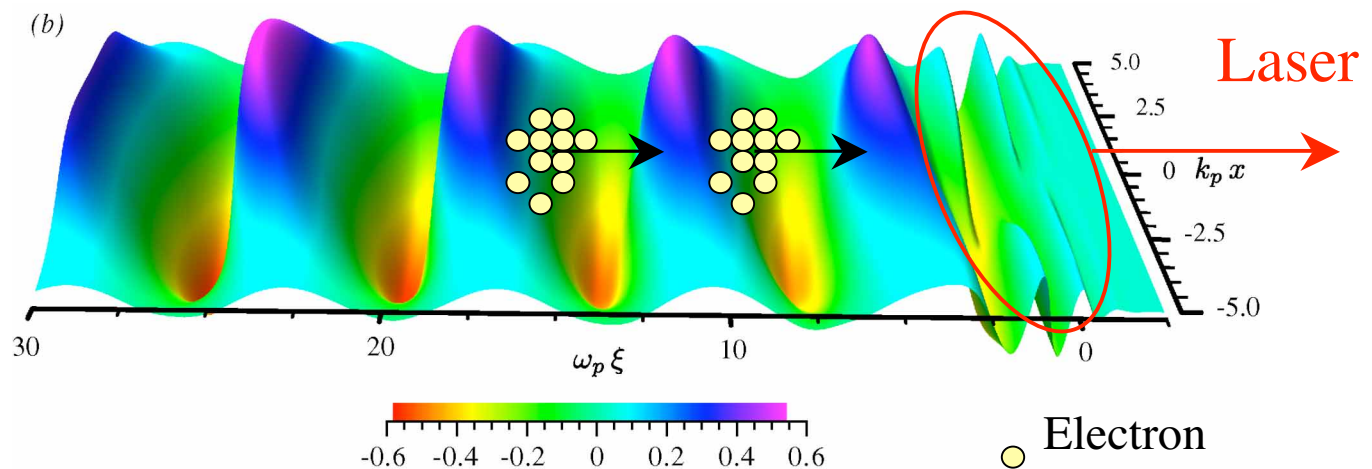

The laser pulse organizes the plasma, producing the charge separation that produces the accelerating field

MODERN SHIPS OF DISCOVERY

Laser driven plasma acceleration results
40 TW laser => 1 GeV e-beam

40 TW laser => 1 GeV e-beam

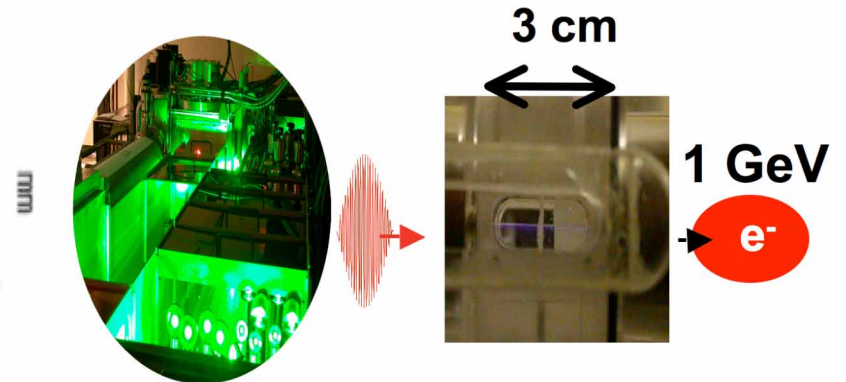
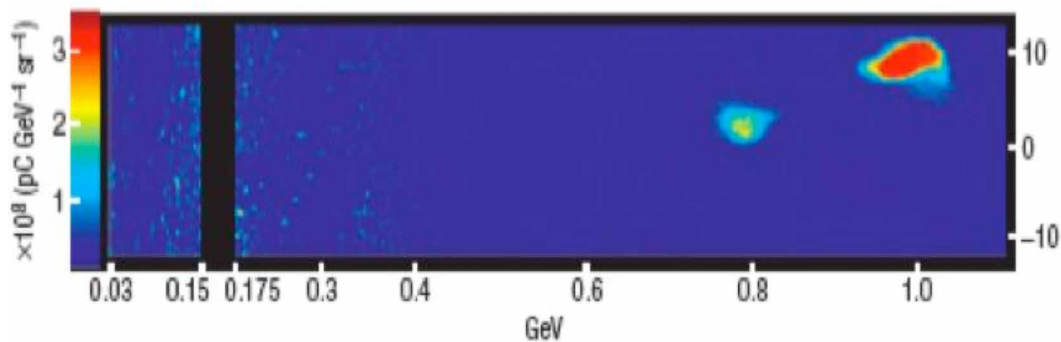

MODERN SHIPS OF DISCOVERY

That's our sampler of a small bit of accelerators and
accelerator based science bringing us up to date

Now let's see about commitments coming up soon:

MODERN SHIPS OF DISCOVERY

The energy frontier is moving abroad

LHC - Geneva Switzerland

Artist's Cutaway

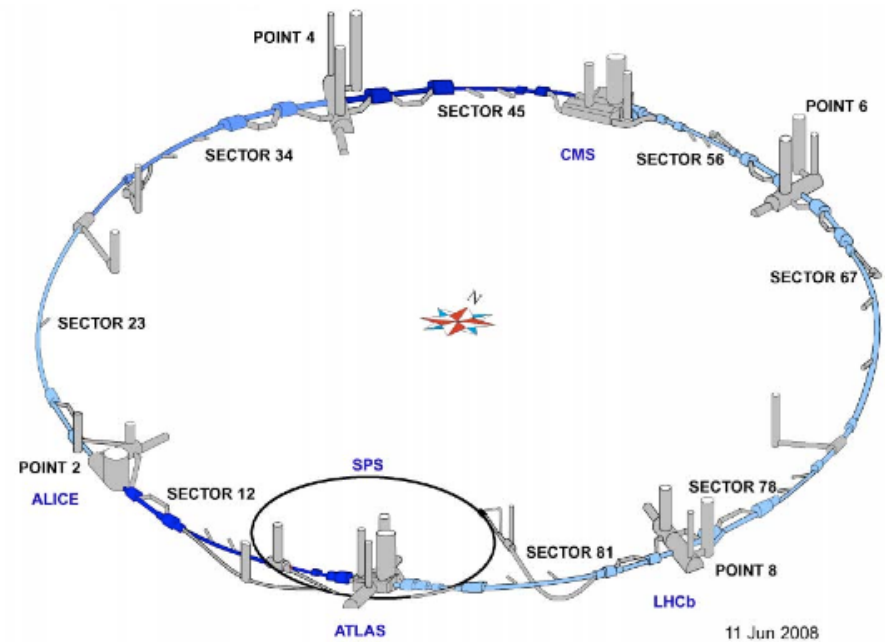

27 km circumference
7 TeV on 7 TeV
begin data this year

Will be used for discovery
elementary particle physics
and heavy ion physics (NP)

MODERN SHIPS OF DISCOVERY

CMS Detector

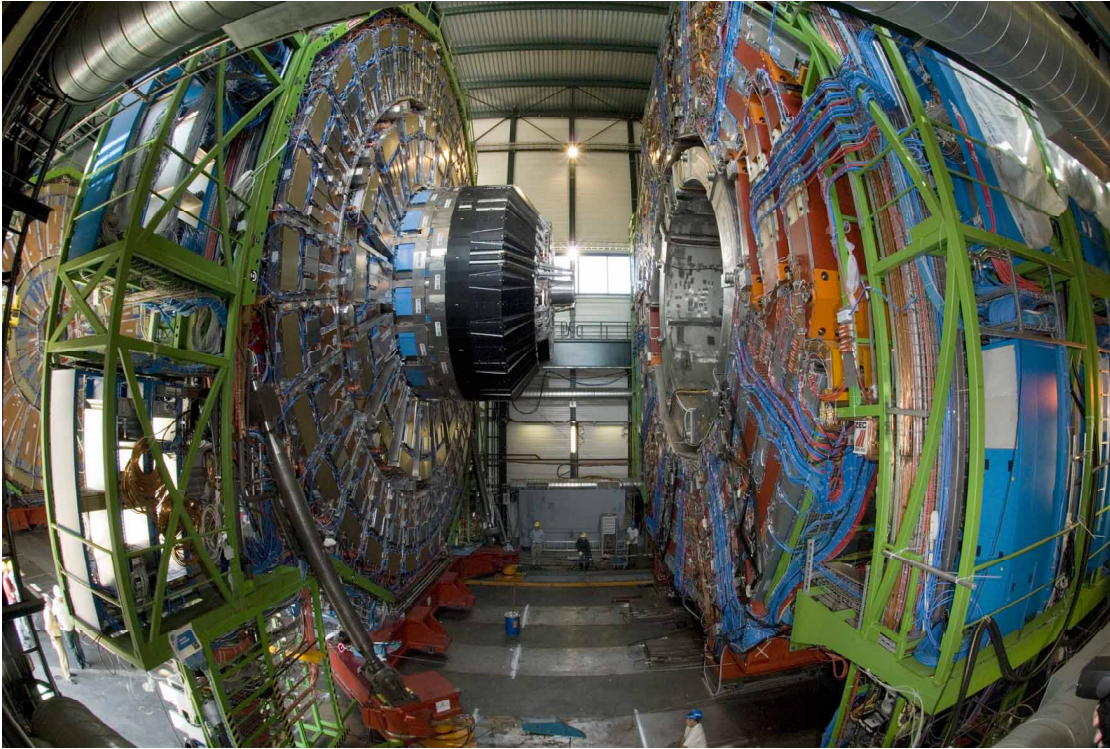

Notice persons at bottom for scale

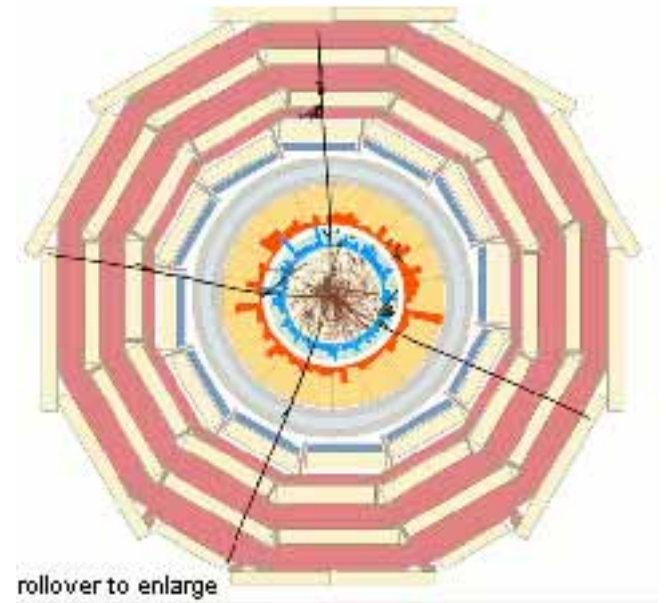

Simulated Higgs decay

MODERN SHIPS OF DISCOVERY

Now under way for Nuclear Science US : FRIB

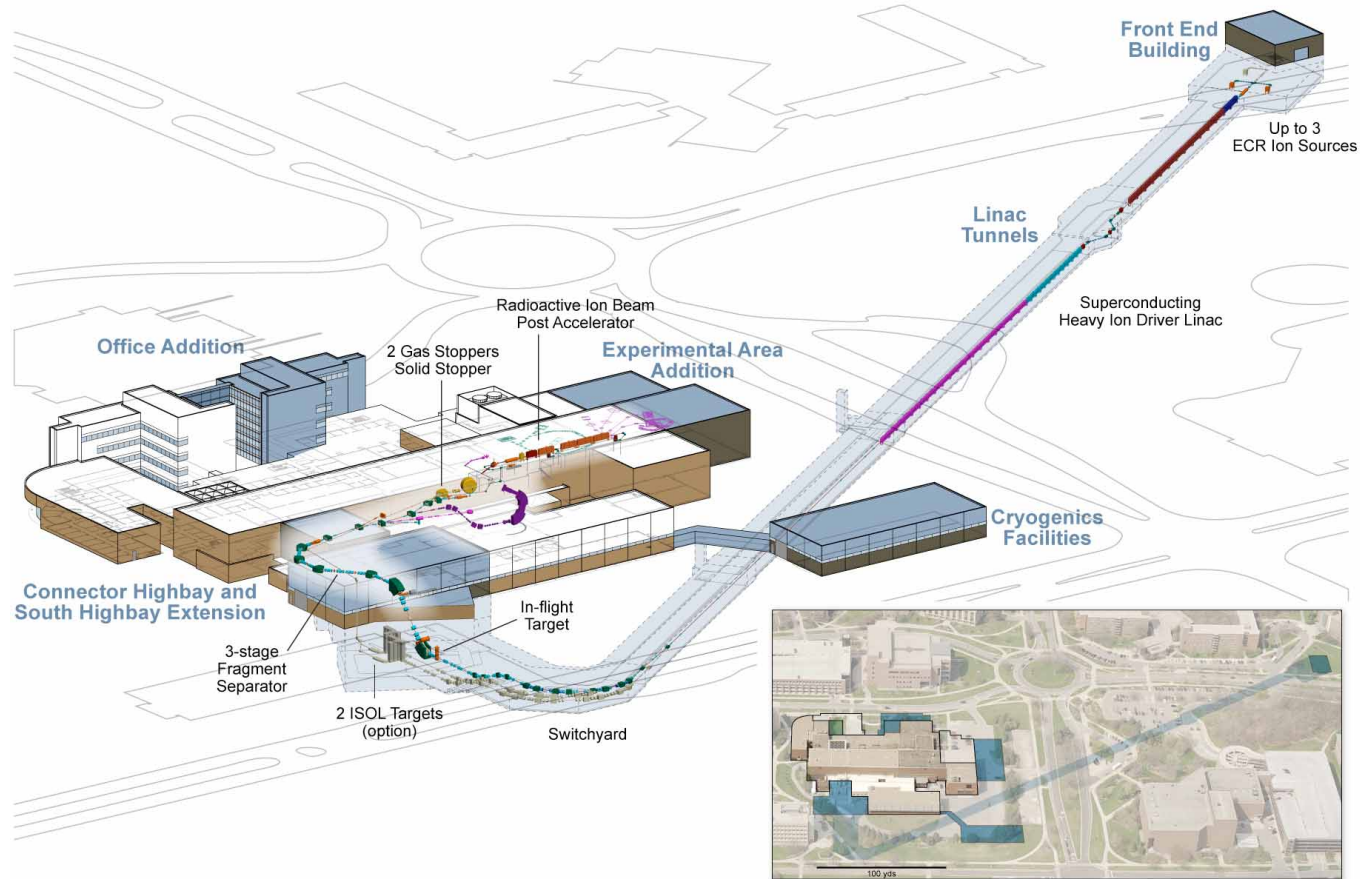

- Science of stellar interiors, super novae, x-ray bursts...
- Testing symmetries of nature and more

MODERN SHIPS OF DISCOVERY

Now under way for nuclear science - CEBAF upgrade

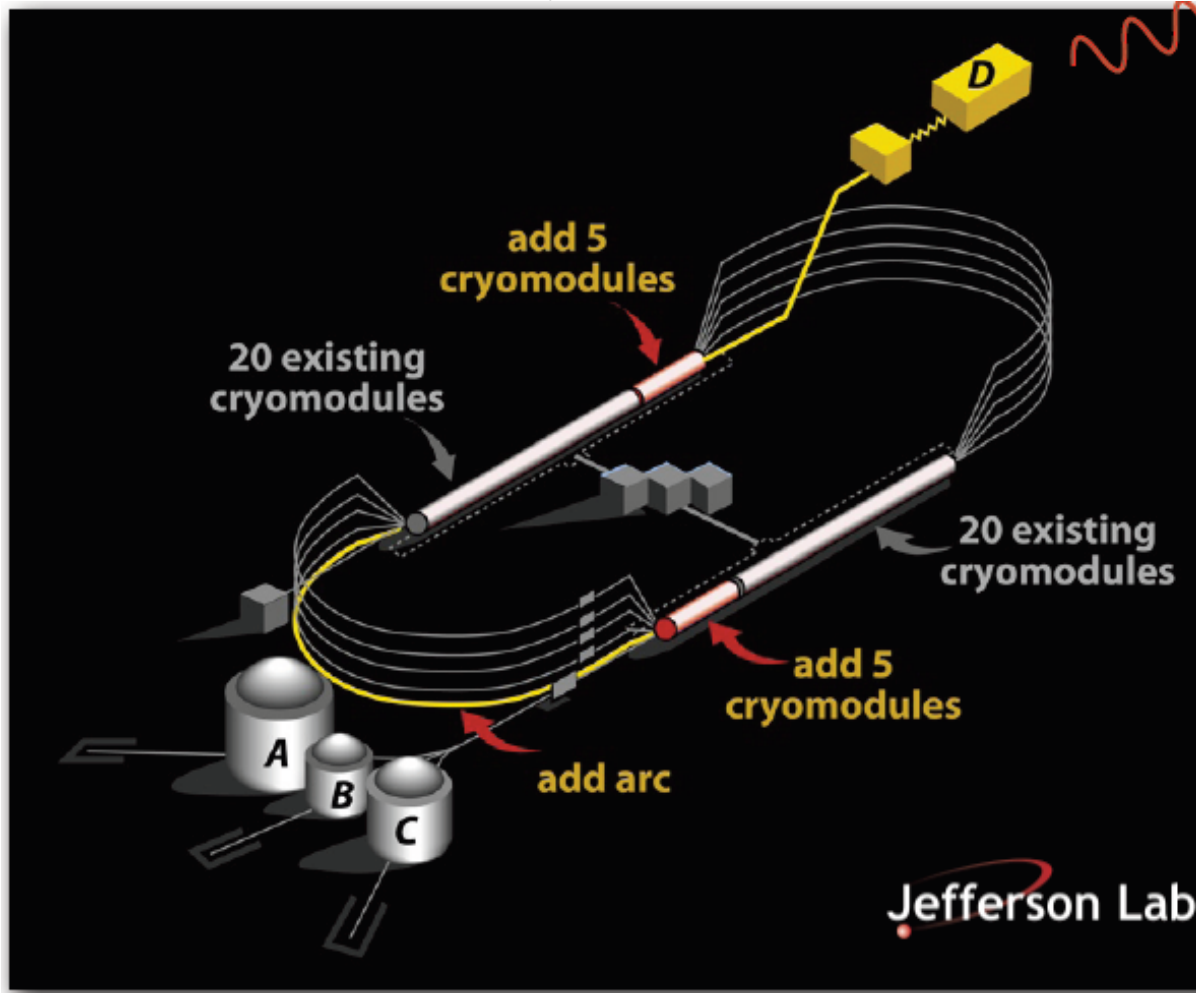

Employs e and γ
To explore the
properties of the
nucleus.

Upgrade raises
energy to 12 GeV

Ultimate goal -
understand how
confinement works

MODERN SHIPS OF DISCOVERY

And-

Here's a look at what's coming on in **accelerator based**
materials science

MODERN SHIPS OF DISCOVERY

Now under construction



NSLS 2
Will offer a
significant
advance over
existing US
storage ring
sources

3 GeV, 791 m circumference

The brightness improvement planned will allow imaging of nano particles with near atomic level resolution

MODERN SHIPS OF DISCOVERY

New on the scene here is the Free Electron Laser able to produce "hard" X-rays with wavelength comparable to atomic dimensions with unprecedented brightness and pulse lengths in the femtosecond (10^{-15} s) range.

Enables atomic level measurements of ultrafast events

The principle:

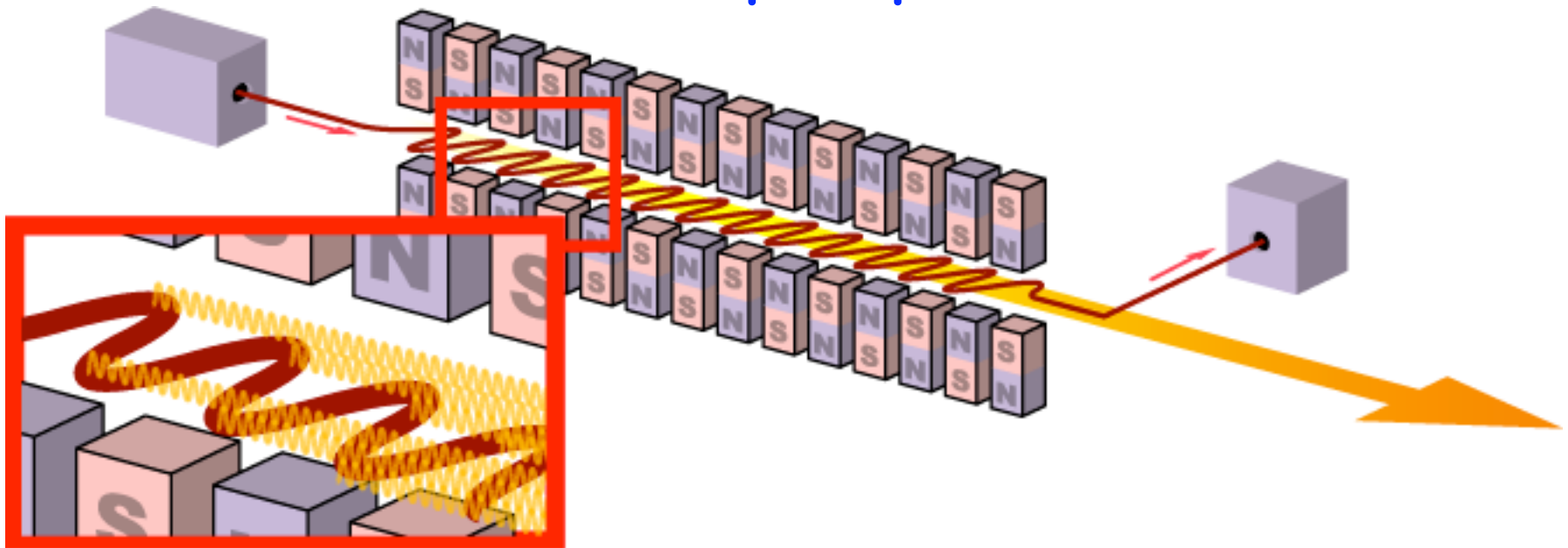

MODERN SHIPS OF DISCOVERY

LCLS conversion of SLAC linac



SLAC
Science
program
just getting
under way
now

Stands to permit determination of structure of important life molecules with a single molecule rather than in crystalline form and much more

MODERN SHIPS OF DISCOVERY

European XFEL

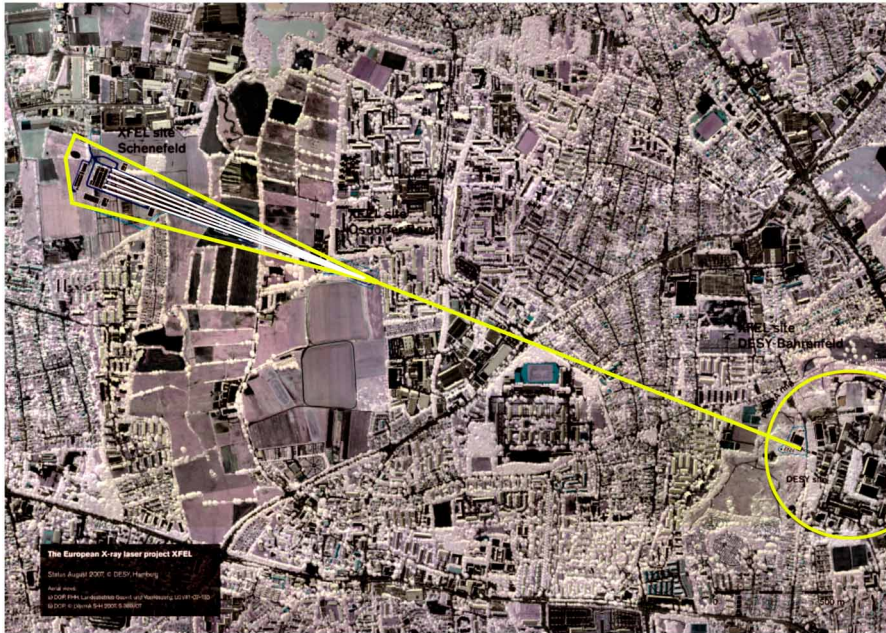

A “purpose built” hard X-ray FEL (0.1 nm wave length)
using superconducting radiofrequency technology
- highest average spectral brilliance -
now under construction

MODERN SHIPS OF DISCOVERY

And

Two new test facilities

for the Science of Accelerators

MODERN SHIPS OF DISCOVERY

FACET - facility

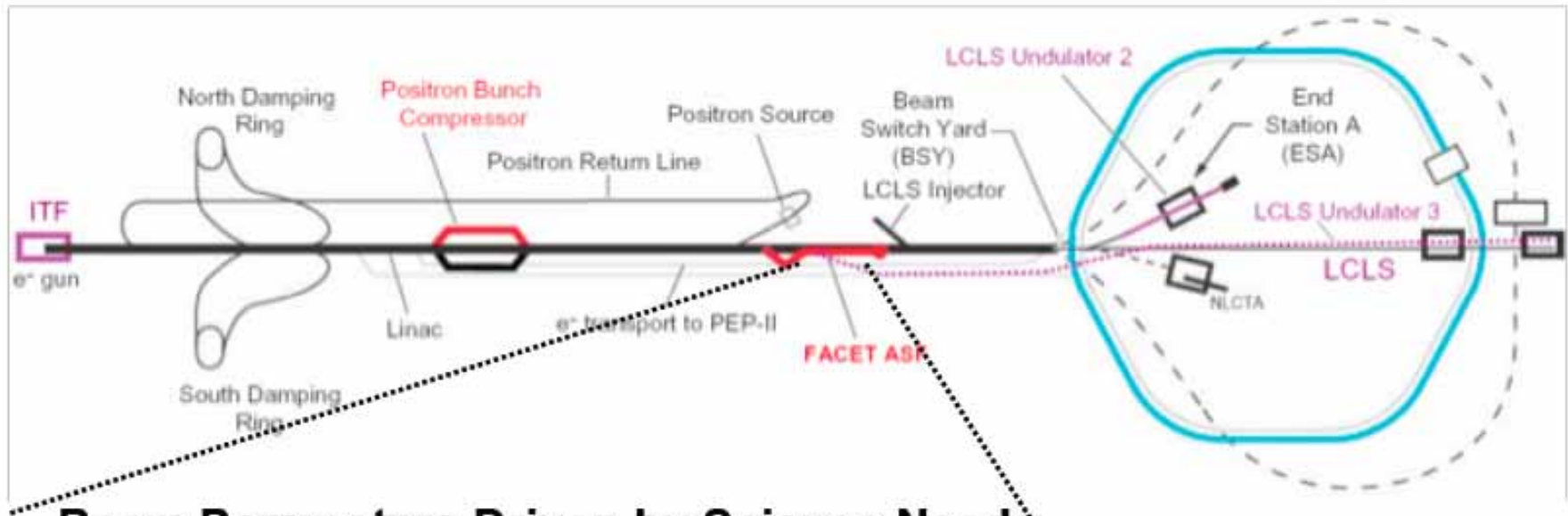

Beam Parameters Driven by Science Needs

Delivered to 100m area with three distinct functions:

1. Chicane for final stage of bunch compression
2. Final Focus for small spots at the IP
3. Experimental Area

Advantageous location:

- Preserves e⁺ capability
- No bypass lines or interference with LCLS
- Linac setup virtually identical to SPPS/FFTB



MODERN SHIPS OF DISCOVERY

Laser Driven Plasma Acceleration - BELLA - facility LBNL

BELLA Laser

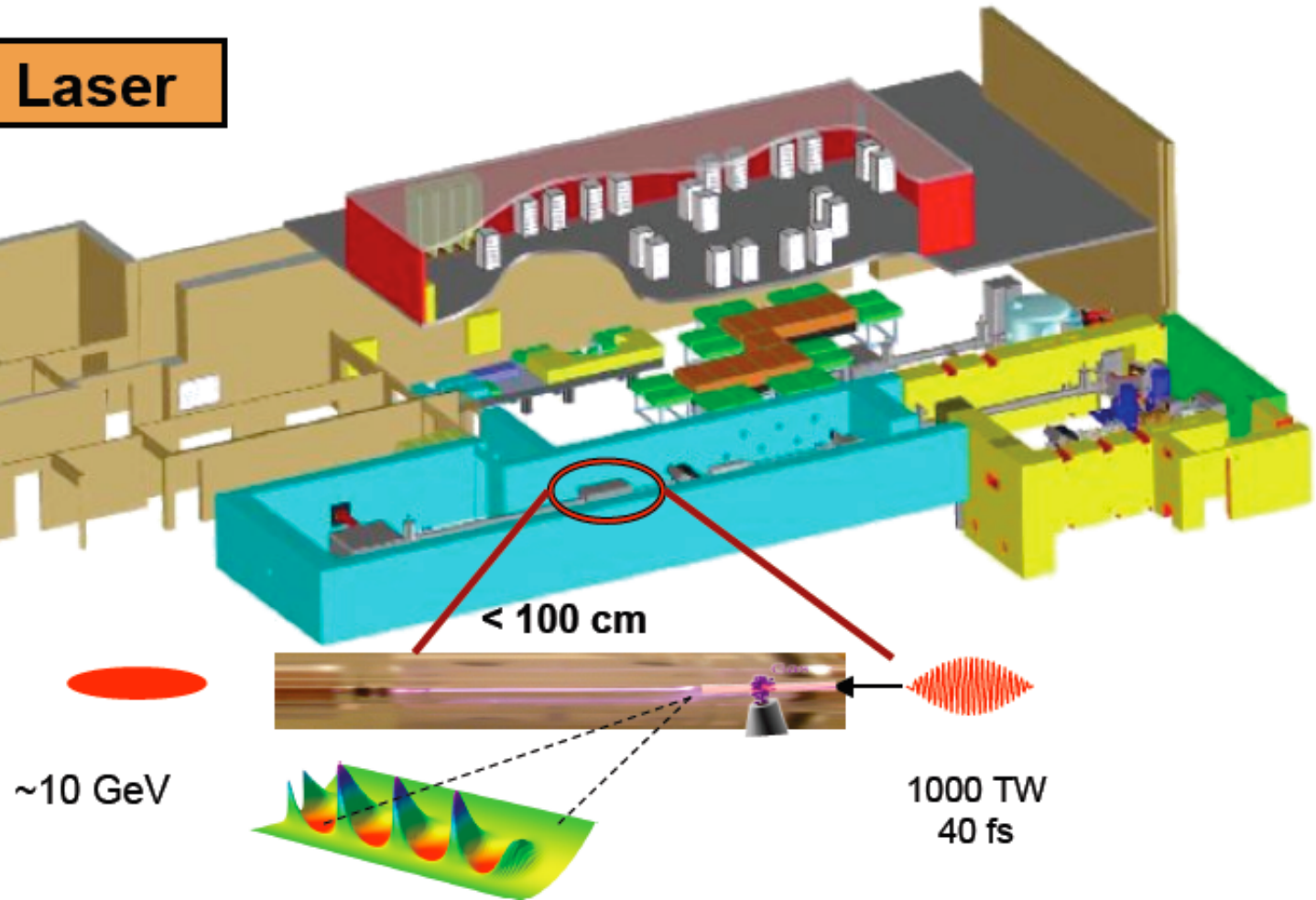

MODERN SHIPS OF DISCOVERY

LOOKING NOW TO THE FARTHER FUTURE AND A FEW
OF THE ACCELERATOR POSSIBILITIES THAT ARE
UNDER ACTIVE DISCUSSION WITH SOME R&D

First Stop

X-ray Science

MODERN SHIPS OF DISCOVERY

Soft X-ray FEL (down to 1 nm wavelength)

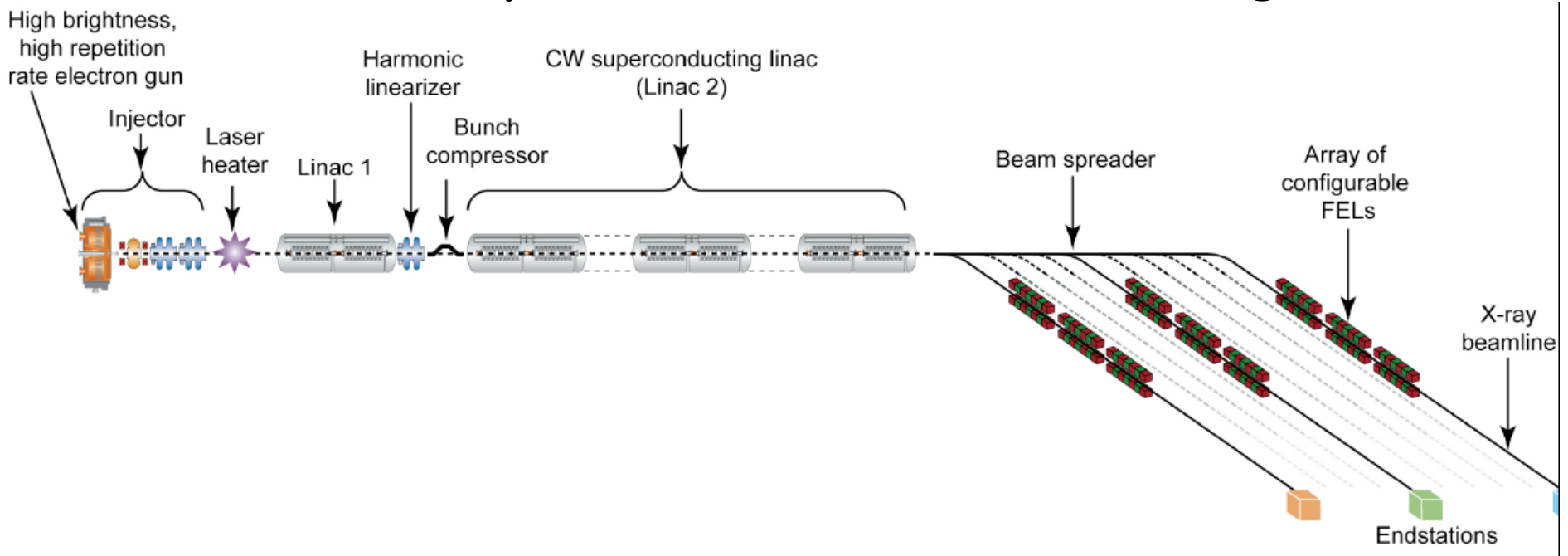

At these longer wavelengths it may be possible to use “seeding” with an optical laser to gain control over the temporal as well as spatial nature of the soft X-rays, to see how atoms are bound together in solids, Hi-Tc....

MODERN SHIPS OF DISCOVERY

Energy Recovery Linac, ERL

Both hard and
soft X-rays
X-hi brightness
accesses smaller
objects down to
atom size

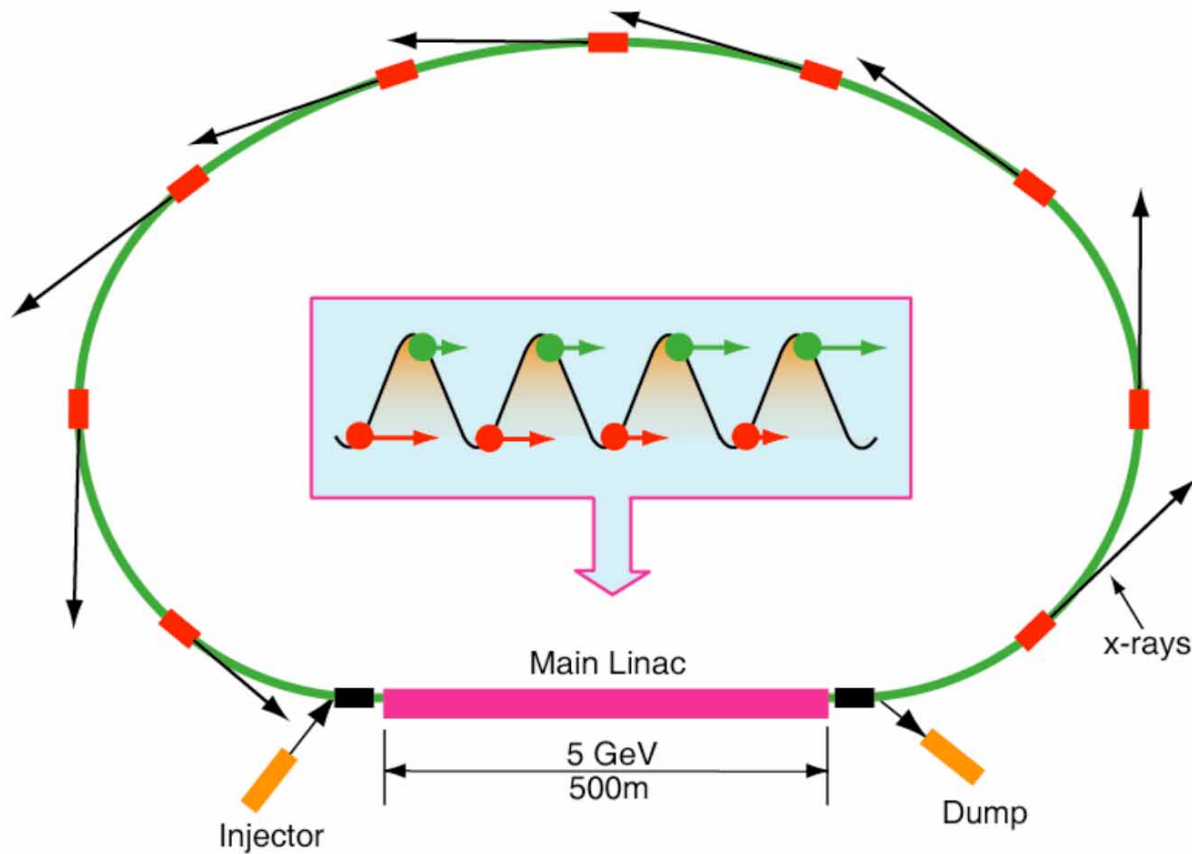

e.g. make
movies of
catalysts in
action

MODERN SHIPS OF DISCOVERY

Ultimate Hard X-ray Storage Ring

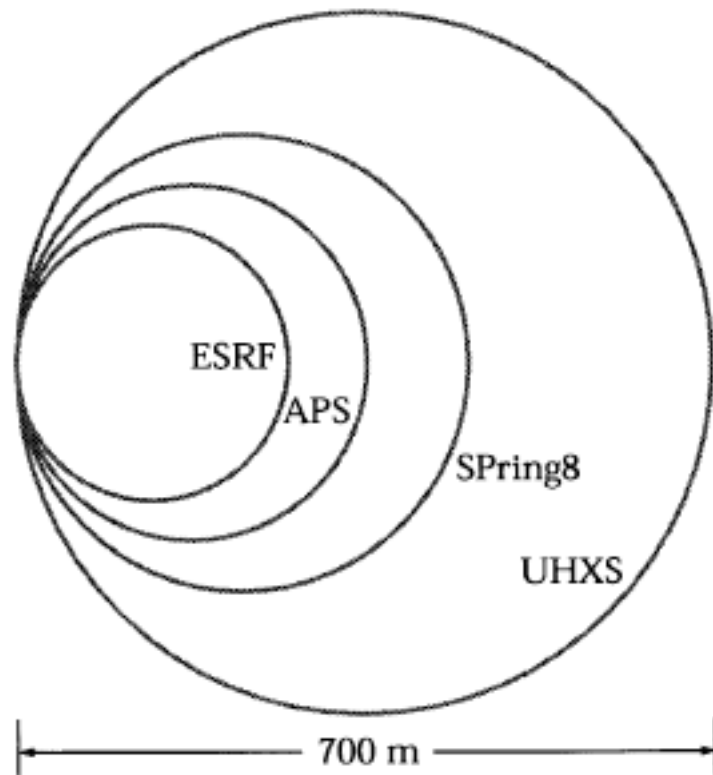

It is thought that perhaps a large enough storage ring with special provisions might rival the X-ray brightness of linac based sources but without the short pulses

MODERN SHIPS OF DISCOVERY

Now on to possible advanced accelerators of the future
for Nuclear Science

MODERN SHIPS OF DISCOVERY

Electron-heavy ion collider

eRHIC one possibility

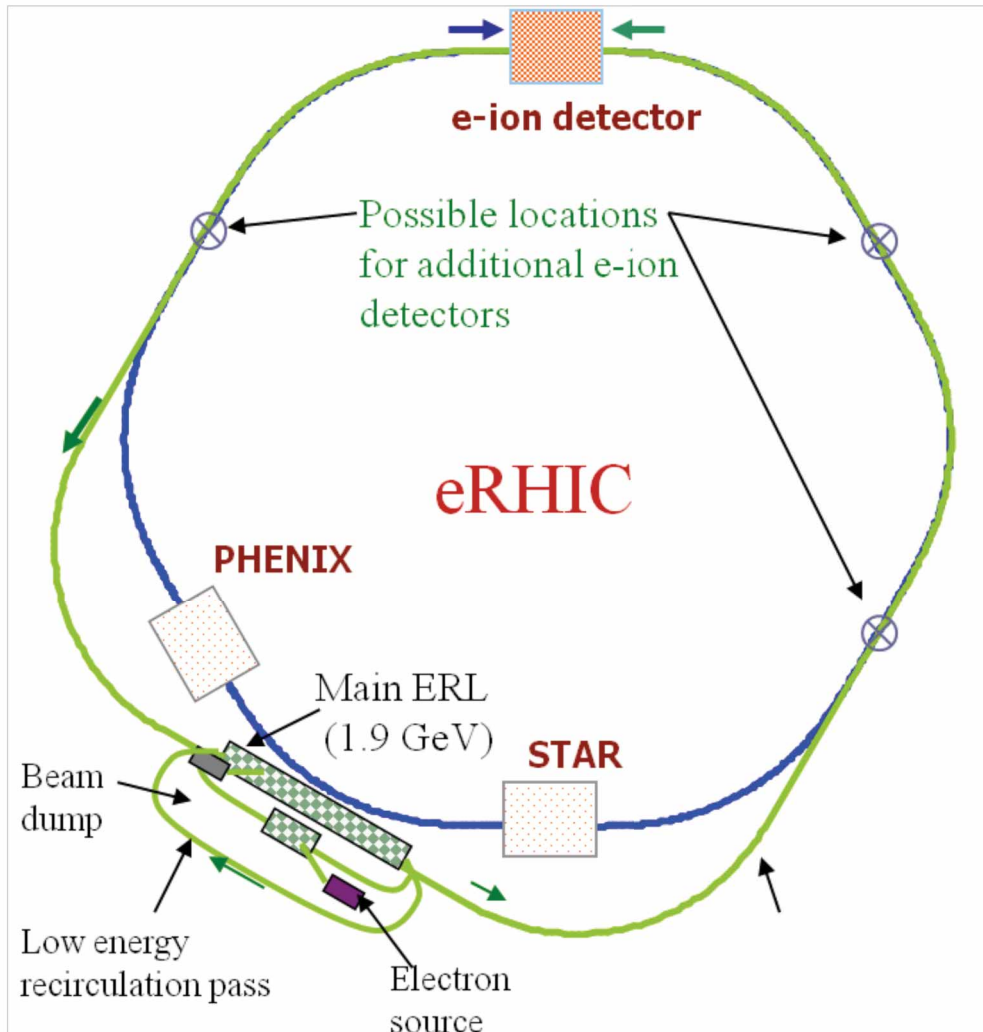

Enables us to look in detail into the sea of quarks and gluons in nuclei, to create and study gluons with hope to discover how energy transforms into matter.

MODERN SHIPS OF DISCOVERY

And for High Energy Physics

MODERN SHIPS OF DISCOVERY

ILC International Linear Collider

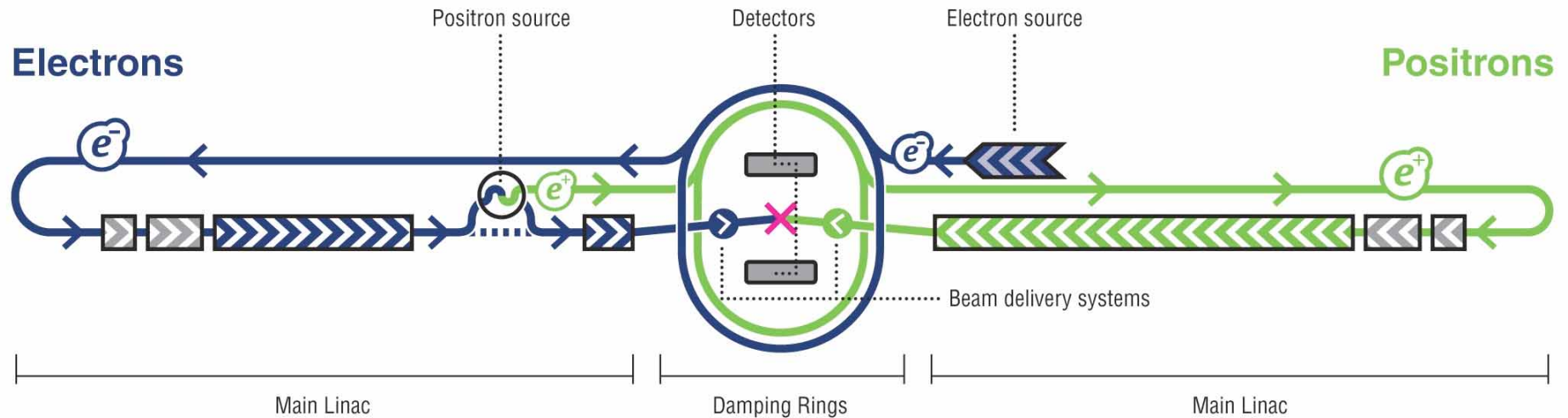

0.5 - 1 TeV total, 33 km length

Identify dark matter suspects, enumerate extra dimensions, check whether Higgs particle suspect(s) fulfill all required characteristics.....

MODERN SHIPS OF DISCOVERY

or perhaps another approach

And for the yet further future - perhaps a muon
collider,.....

MODERN SHIPS OF DISCOVERY

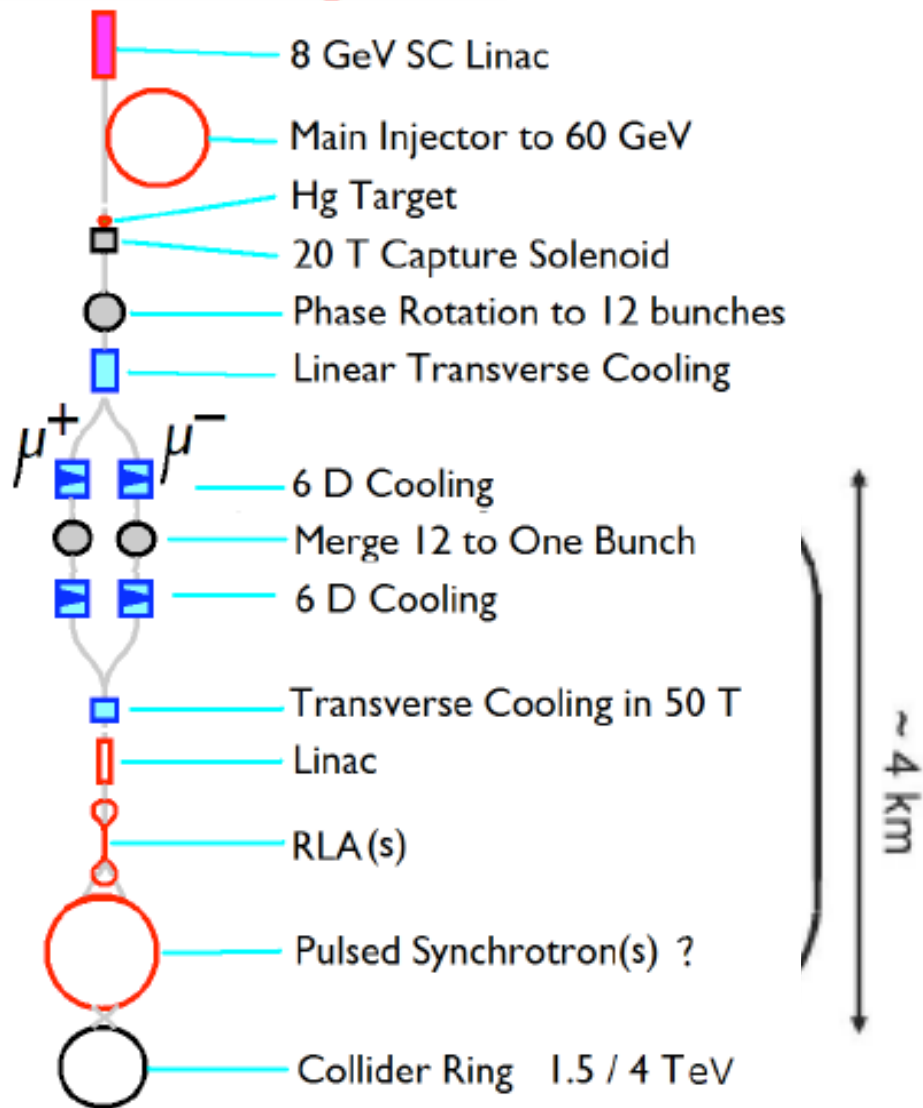

MODERN SHIPS OF DISCOVERY

Future possibilities for Plasma based acceleration

Radiation Production with *Beam Generated* plasma wakefield

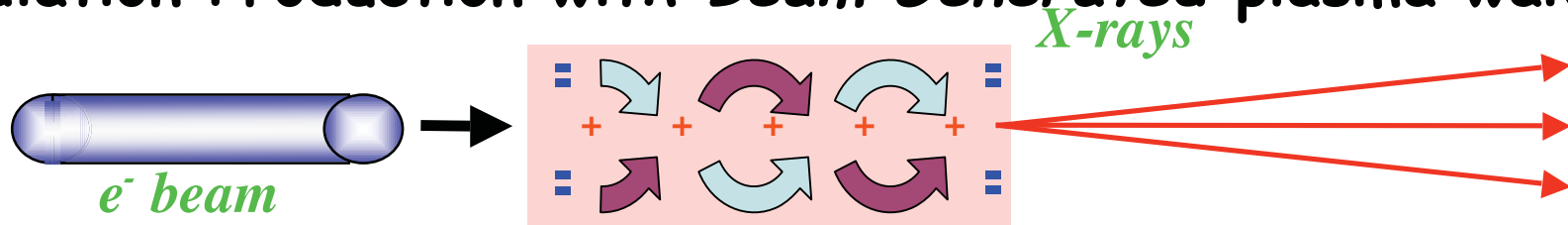

It may eventually be possible to apply these principles to obtain very high energies for elementary particle physics

Radiation production with *Laser Generated* plasma wakefield

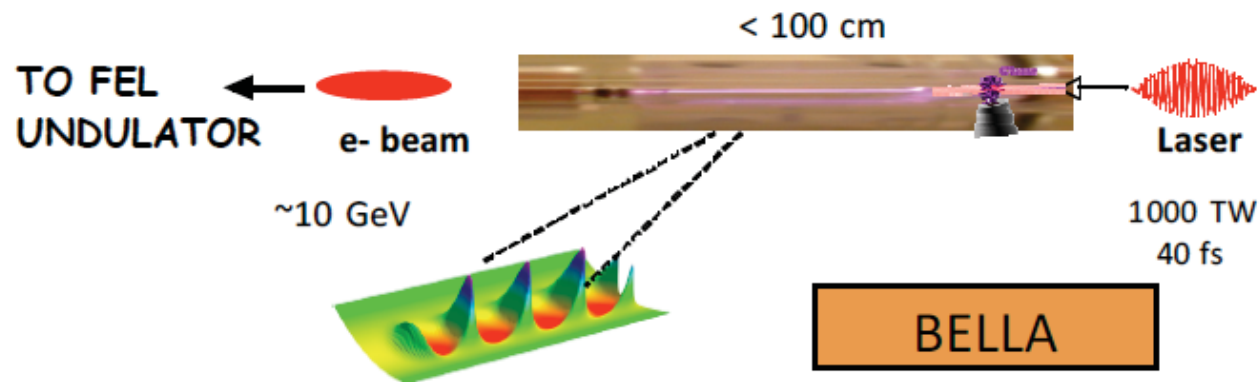

MODERN SHIPS OF DISCOVERY

We've seen:

Small samplings of where we've been,

What we are committed to for the near and mid-term,

Where we might go in the further future in accelerators
for the accelerator based sciences and in the *science of
accelerators*

MODERN SHIPS OF DISCOVERY

Assuring future accelerators

**to support the evolution of sciences depending on
accelerators requires a conscious and continuing effort
in support of the science of accelerators**

MODERN SHIPS OF DISCOVERY

Accelerator science is a **SCIENCE** and needs to be conceived of as such in order to nurture it properly. As in other sciences it is built up step by step with syntheses and implementations often taking many years for acceptance of the ideas and development of the technologies needed for that implementation.

MODERN SHIPS OF DISCOVERY

The collage below displays some of the scientific and technology elements that have played and are playing important roles in bringing accelerator science forward and in realizing implementations now in late stages of development - generic accelerator R&D elements.

MODERN SHIPS OF DISCOVERY

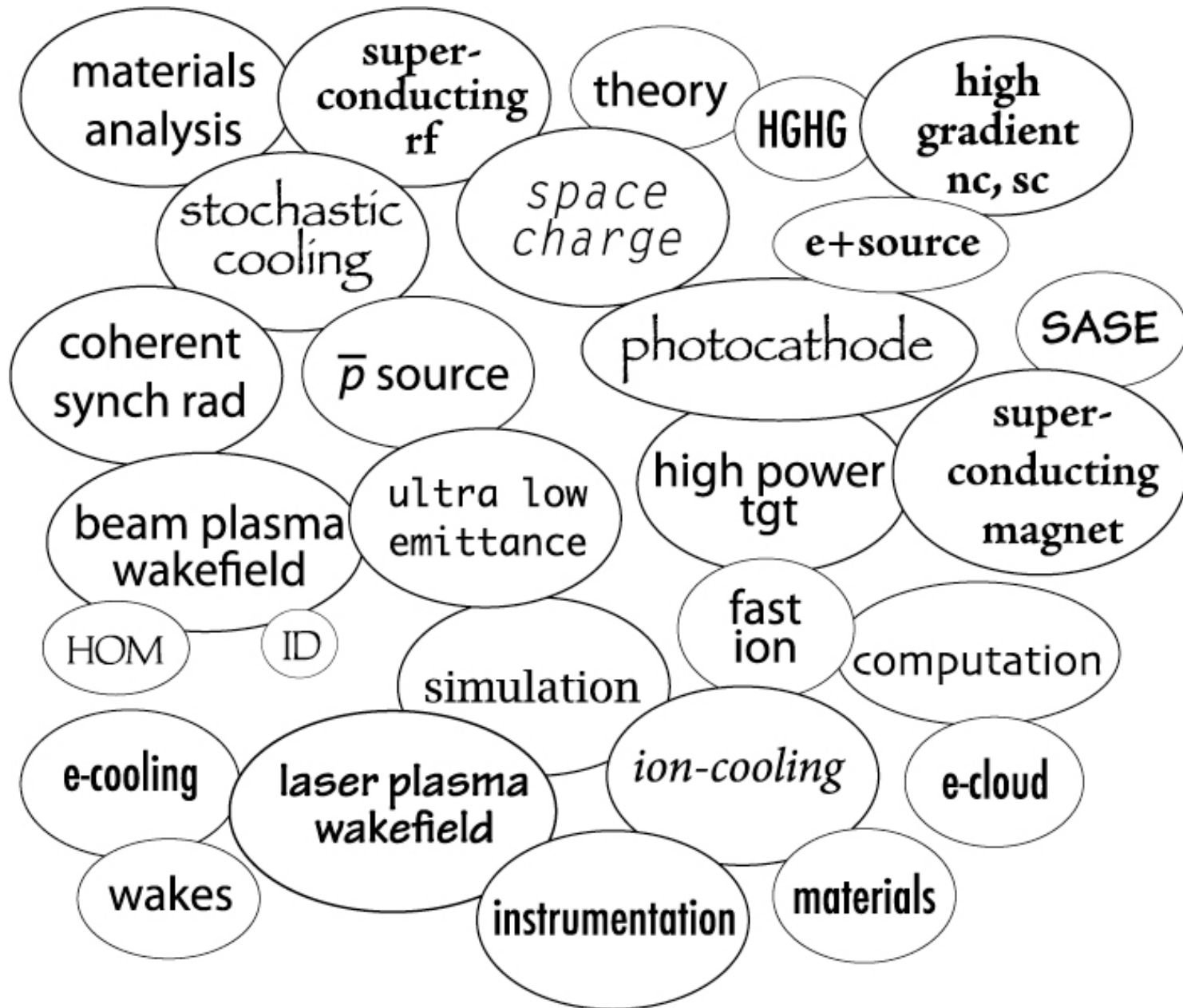

MODERN SHIPS OF DISCOVERY

STRONG SUPPORT FOR THESE ELEMENTS IS
ESSENTIAL FOR ASSURING

Accelerators for America's Future

MODERN SHIPS OF DISCOVERY

ACKNOWLEDGEMENTS

D. Bilderback

J. Brock

J. Butler

E. Clements

J. Friedman

K. Gelbke

S. Gruner

S. Henderson

W. Henning

M. Hogan

K. Munday

W. Leemans

L. Meringa

S. Nagler

D. Neumann

P. Oddone

S. Ozaki

J. Schneider

M. Szbenyi

R. Taylor